



Key Benefits

- ▶ 16.2" LED, 1920 x 1200 **WUXGA** native resolution
- ▶ 16.7 M colors (8-bit) / 300 cd/m² brightness
- ▶ PIP Sub-screen & PBP Dual-screen viewing efficiency
- ▶ HDMI 1.4 + DVI-D + VGA video input
- ▶ Rugged structure ensures high mobility
- ▶ IP65 front protection (NAP series)
- ▶ Professional-use durability & around-the-clock operation
- ▶ 2-year standard warranty (upgradable up to 5 years)

Applications

- Broadcasting / Advertising
- Traffic control / Command center
- Directory / Ticket kiosk
- Surveillance system
- Vehicle mount display
- Bathroom TV

UltraView X17 series 16.2" WUXGA LED monitor supports 1920 x 1200 resolution. 16.7 million colors achieve optimal picture quality. Improved energy efficiency and fan-less architecture provides professional-use durability and around-the-clock operation.

X17 is more than just a standalone monitor. UltraView has a variety of embedded modules including Multi-Monitor OSD Controller and SDI Input. The embedded modules give you the ability of video remote management and transmission for multiple monitors over network.

As a versatile 1920 x 1200 monitor, X17 is meticulously designed to meet professional and environmental demands including IP54 Front protection, Touchscreen, Anti-reflective/Vandal proof glass, DC power input, Brightness dimming and Mounting kit for Panel-mount, VESA-mount, Universal-mount and Desktop stand.

With over 22 years' production experience, the X17 structure is well-engineered and manufactured by our own CNC facilities and team of experts to ensure its ruggedness, mobility and quality, as well as being suitable for harsh environment applications. The structure can be customized if required to facilitate monitor installation. Our knowledgeable engineers are able to provide frame customization for specific dimensions, color, metal treatment, screen printing, bezel and mounting.

Options

Video Management & Transmission over Network

- Embedded Multi Monitor OSD Control Module over serial
- Embedded 3G / HD / SD-SDI Input Module
- Embedded Brightness Dimming Module

Touchscreen & Glass Protection

- 5-Wire Resistive 1-point Touch
- Anti-reflective Glass
- Vandal Proof Glass

DC Power

- 12V / 24V / 48V / 125VDC (50 Watt)

Bezel & Frame Customization

- Dimension
- Color & Treatment
- Screen Printing
- Stainless Steel Bezel

Mounting

- VESA mount, 100 x 100mm (bundled)
- Universal mount (ready for OP model)
- Desktop stand (option)
- Panel mount (bundled)

6mm aluminum front bezel



AP-X17

6mm aluminum front bezel
NEMA 4 / IP65 front protection



NAP-X17

Aluminum front cover



DP-X17

Universal open frame



OP-X17

Diagrams (mm)

Front View

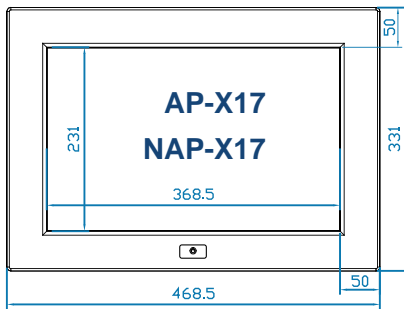

Side View

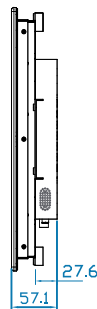

Rear View

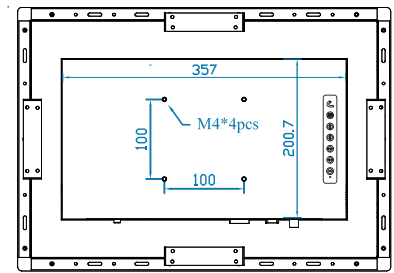

Front View

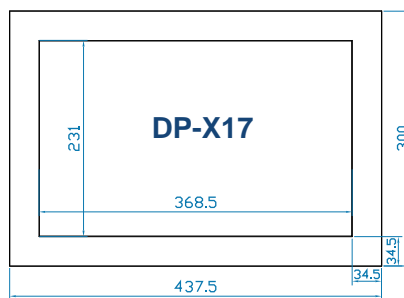

Side View

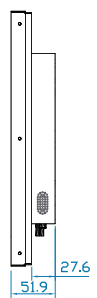

Rear View

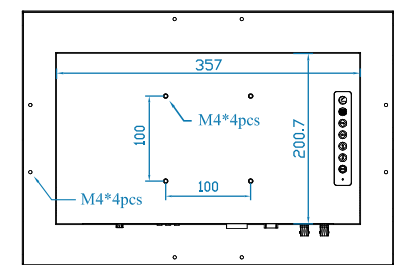

Front View

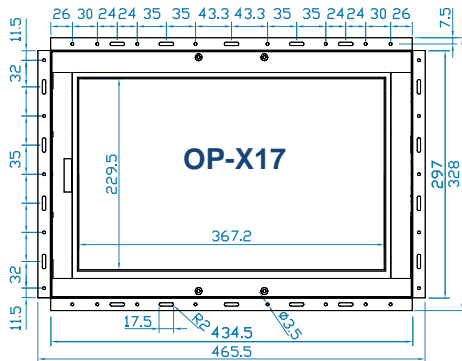

Side View

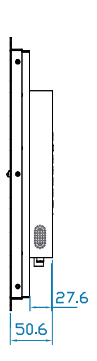

Rear View

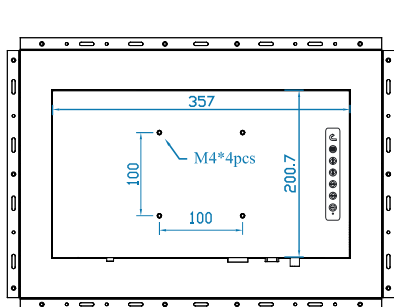

Options — Video Management & Transmission over Network

Embedded Multi Monitor OSD Control Module over serial

- Remote control the monitor OSD via RS-232C serial interface
- Daisy chain up to 64 monitors via Cat5/6 cable
- Individual ID for individual monitor OSD settings
- Power ON or OFF monitor
- Adjust brightness & audio
- Switch video sources

Up to 64 monitors
Up to 1,000m distance

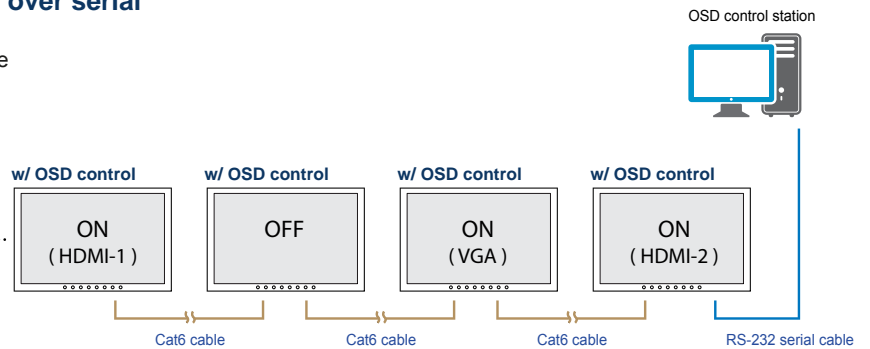

Part no.

Embedded Multi Monitor OSD Control Module : **MCS**

Embedded 3G / HD / SD-SDI Input Module

- Intelligent SDI monitoring with broadcast quality scopes
- Supports multi-rate 3G / HD / SD-SDI format
- Provides input to output loop-through capability
- Auto format sensing & selection

Part no.

Embedded 3G / HD / SD-SDI Input Module : **SDI**

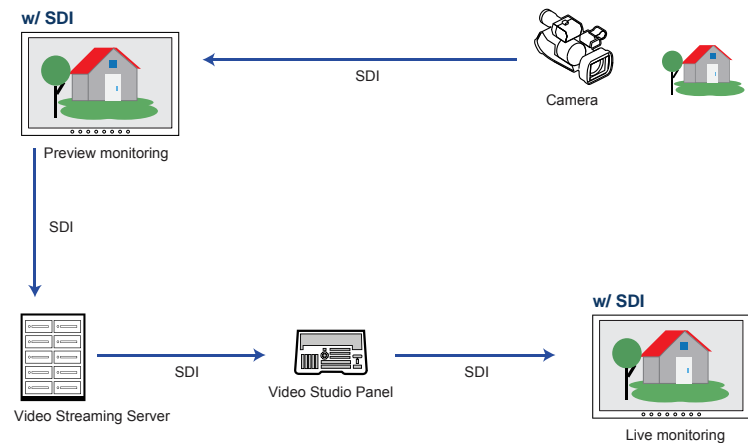

Embedded Auto Brightness Dimming Module

- Brightness changes according to its ambient brightness
- Its brightness change causes 10% increase or decrease

Part no.

Embedded Brightness Auto Dimming Module : **DA-01**

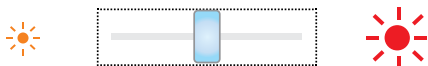

Embedded Manual Brightness Dimming Knob

- Easy-to-use IP54 dimming knob on the front panel
- One click causes 2% brightness increase or decrease
- Brightness adjustment from 0% to 100%

Part no.

Brightness Dimming Knob : **DS-01**

Option — e-Resistive 1-point Touch

	TRB e-Resistive
Technology	5-Wire Resistive
Touch Point	Single
Input Type	Finger or Stylus
Resolution	2048 x 2048
Response Speed	15 ms
Activation Force	≤ 50 g
Surface Hardness	3H
Light Transmission	80% ± 3%
Haze	8% ± 3%
Durability	10 million touches
Top Layer	ITO Film
Bottom Layer	ITO Glass
Thickness	2.2 ± 0.2 mm
Connector	USB Type A
Compatibility	Windows 7 / XP / Linux / Mac

Part no. : X17TRB

** Dimension will be changed if multi-touch required

Options — DC Power

		12V	24V	48V	125V
Input rating	Input voltage	12-Volt	24-Volt	48-Volt	110-Volt
	Input range	9 ~ 18V	18 ~ 36V	36 ~ 75V	66 ~ 160V
Input current	No load	50 mA	50 mA	50 mA	35 mA
	Full load	4950 mA	2450 mA	1220 mA	749 mA
Output rating	Output voltage	12-Volt	12-Volt	12-Volt	12-Volt
	Output current	4.16A	4.16A	4.16A	6.25A
Efficiency		84%	85%	85%	91%

Part no. : 12VDC
24VDC
48VDC
125VDC

Product Specifications

LCD Panel	
Panel size (diagonal)	16.2-inch widescreen TFT color LCD
Native resolution	1920 x 1200
Brightness (cd/m ²)	300
Contrast ratio (typ.)	800 : 1
Colors	16.7 M, 8-bit
Viewing angle (L/R/U/D)	89/89/89/89
Response time (ms)	30
Dot pitch (mm)	0.191
Display area (mm)	343.8H x 214.9V
Surface treatment	Anti-glare, Hard-coating
Surface hardness	3H
Backlight type	LED
MTBF (hrs)	20,000

Design	AP-X17	NAP-X17	DP-X17	OP-X17
Protection	6mm front bezel	NEMA 4 / IP65	front cover	open frame
Front panel	Black, RAL 9005			-
Rear casing	Black, RAL 9005			

Mounting	AP-X17 / NAP-X17	DP-X17	OP-X17
VESA mount	100 x 100 mm	100 x 100 mm	100 x 100 mm
Universal mount	-	-	ready
Desktop stand	option	option	-
Panel mount	bundled	-	-

Video	
Digital :	
DVI	DVI-D single link
HDMI	HDMI 1.4 / HDCP 1.4
Analog :	
VGA	Analog 0.7Vp-p

Physical	AP-X17 / NAP-X17		DP-X17	OP-X17
Product (W x D x H) :	mm	468.5 x 57.1 x 331	437.5 x 51.9 x 300	465.5 x 50.6 x 328
	inch	18.4 x 2.2 x 13	17.2 x 2 x 11.8	18.3 x 2 x 12.9
Packing (W x D x H) :	mm	615 x 113 x 523	615 x 113 x 523	615 x 113 x 523
	inch	24.2 x 4.4 x 20.6	24.2 x 4.4 x 20.6	24.2 x 4.4 x 20.6
Net weight	4.9 kg / 10.8 lb	5.6 kg / 12.3 lb	4.4 kg / 9.7 lb	3.8 kg / 8.4 lb
Gross weight	7.7 kg / 16.9 lb	8.4 kg / 18.5 lb	7.1 kg / 15.6 lb	6.5 kg / 14.3 lb
Chassis color	Dark			
Chassis materials	Aluminum			

Audio	
Audio output :	
Connector	3.5mm stereo jack
Resistance / Power level	30kΩ / 2.8V
Speaker :	
Dual stereo speaker	10W x 2

*When the audio output is connected, speaker output is OFF

Compliance	
EMC	FCC & CE certified
Safety	CE / LVD certified
Environment	RoHS2 & REACH compliant

Power	
Input	Auto-sensing 100 to 240VAC, 50 / 60Hz
Consumption :	
Screen on	Max. 34W
Power saving mode	Max. 4W
Power button off	Max. 1W

Applicable Format			
DVI-D / VGA Input	PC signal	1920 x 1200 x 60Hz	
		1360 x 768 x 60Hz	
		1280 x 1024 x 60 / 75Hz	
		1280 x 960 x 60Hz	
		1280 x 768 x 60 / 75Hz	
		1152 x 864 x 75Hz	
		1024 x 768 x 60 / 70 / 75Hz	
		848 x 480 x 60Hz	
		800 x 600 x 60 / 72 / 75Hz	
		720 x 400 x 70Hz	
HDMI input	PC signal	640 x 480 x 60 / 72 / 75Hz	
		640 x 400 x 70Hz	
		640 x 400 x 70Hz	
		640 x 350 x 70Hz	
		2ch Linear PCM	
	HDMI 1.4	Same as VGA	1920 x 1080 x 50 / 60Hz (1080p)
			1920 x 1080 x 25 / 30Hz (1080i)
			1280 x 720 x 50 / 60Hz (720p)
			720 x 480 x 50 / 60Hz (576p / 480p)
			2ch Linear PCM

Environment	
Operating temp.	0 to 55°C degree
Storage temp.	-20 to 60°C degree
Operating humidity	20~90%, non-condensing
Storage humidity	5 ~90%, non-condensing
Operating altitude	16,000 ft
Non-operating altitude	40,000 ft
Shock	10G acceleration (11ms duration)
Vibration	10~300Hz 0.5G RMS random vibration

UltraView Family

UltraView series covers a full range of professional LCD display sizes from 6.5" to 55". Please select from the below the most suitable model for your application.

Sales Inquiry

inquiry@austin-hughes.com

Technical Support

support@austin-hughes.com

16 : 9 (4K)

- K55"
- K43"
- K32"
- K28"
- K23"
- K17"
- K15"

16 : 9 (1080p)

- F55"
- F43"
- F32"
- F28"
- F23"
- F21"
- F17"
- F15"

16 : 10

- X24" (1920 x 1200)
- X17" (1920 x 1200)
- W19" (1440 x 900)

4 : 3

- 20" (1600 x 1200)
- 19" (1280 x 1024)
- 17" (1280 x 1024)
- 15" (1024 x 768)
- 12" (800 x 600)
- 10" (800 x 600)
- 8" (800 x 600)
- 6" (640 x 480)

Sunlight Readable

16 : 9 (4K)

- K55"
- K43"
- K32"

16 : 9 (1080p)

- F55"
- F43"
- F32"
- F21"
- F17"
- F15"

16 : 10

- W19" (1440 x 900)

4 : 3

- 19" (1280 x 1024)
- 17" (1280 x 1024)

Austin Hughes has an extensive distribution network, including EMEA, the Americas & APAC.

Contact your nearest sales office for details of local presentation.

Sales Inquiry

inquiry@austin-hughes.com

Technical Support

support@austin-hughes.com

Distributed by:

Distributor by country on application